

758,3
Height including atmos heating

596,7
Height excluding atmos heating

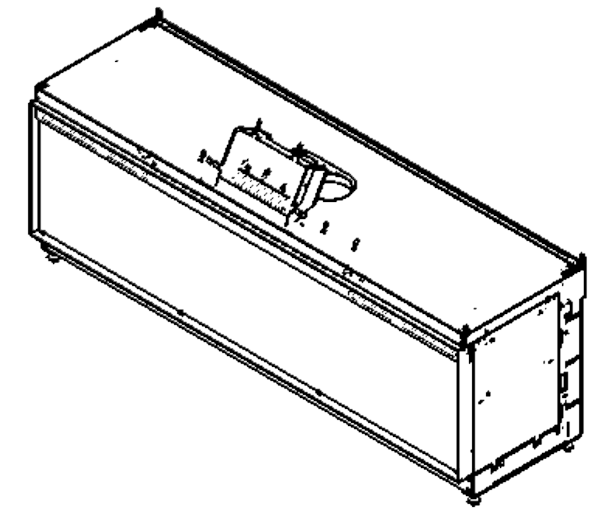
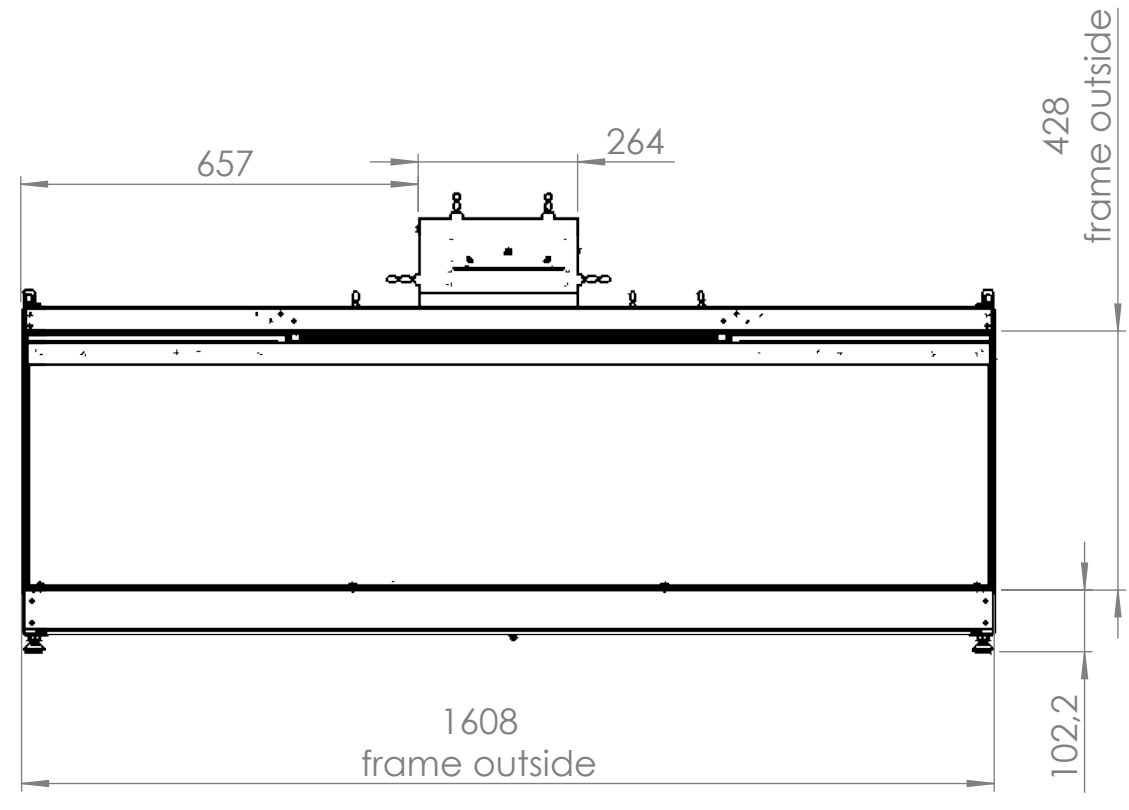
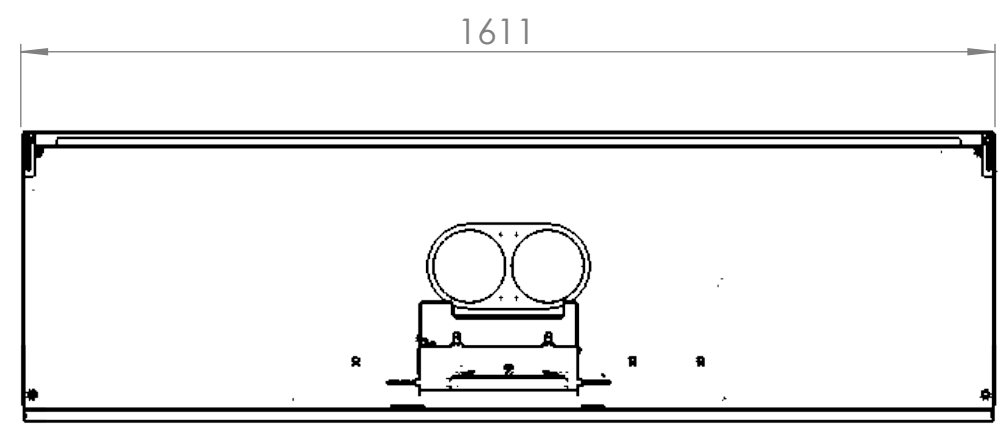
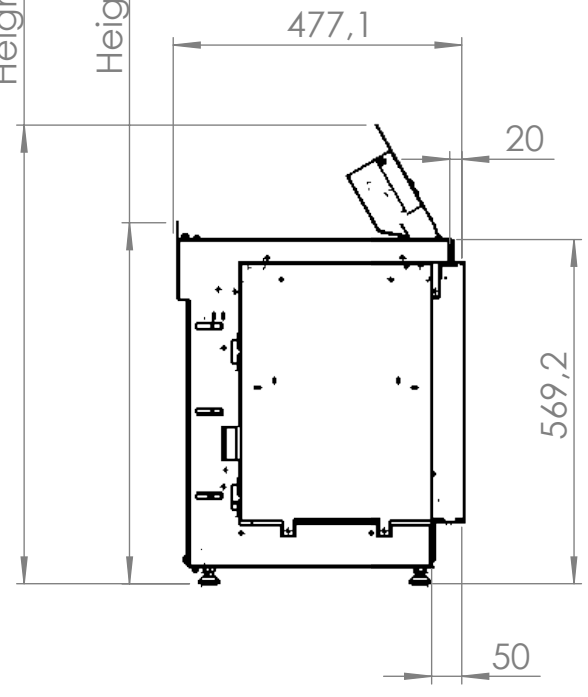

Note:
 Minimum of 2mm clearance around frame.
 All materials must withstand a temperture of minimum 80 degrees.
 A minimum of 100 cm2 of free area is required.
 Ventilation must be provided at both the bottom and top of the housing.

<h1>KALFIRE</h1> <p>FIREPLACES</p>	Treatment:			
	Material:			
Mass (Kg): 105.95	Date: 4-4-2023	Author: MM	Third Angle Projection ISO 128-Method A	
Description: E-ONE 160 F				
Drawing number: KF05239			Rev.: 00	Scale: 1:12,5 A3
All rights reserved. All dimensions in mm. Copyrighted / Reprints prohibited. Kal-fire BV.			Page: 1/1	
State : In Progress				